

1.

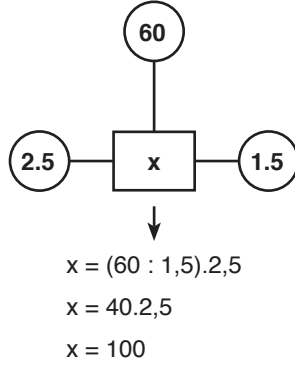

Cevap: E

2.

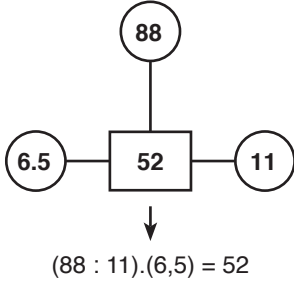
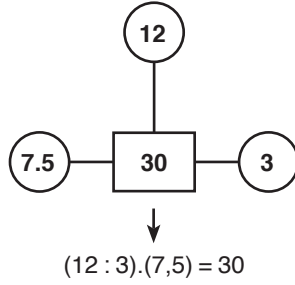
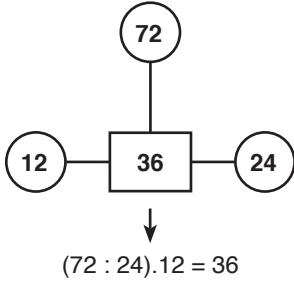
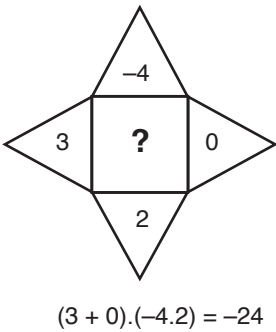
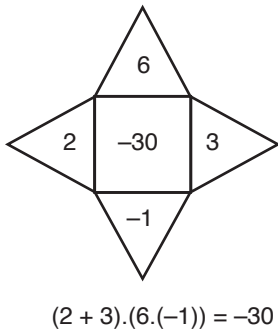
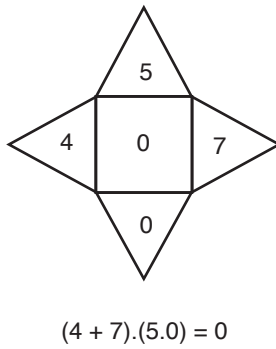
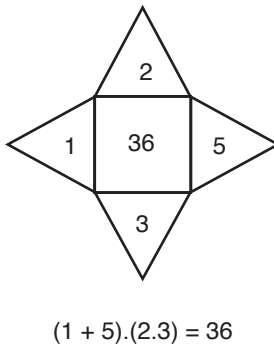

Cevap: B

3.

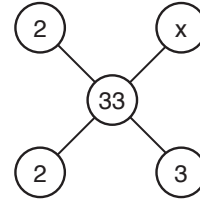
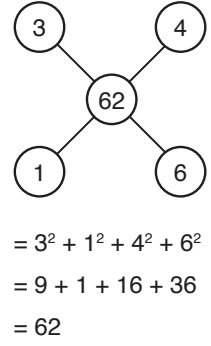
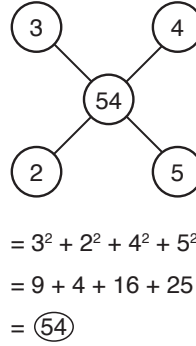

$\Rightarrow 2^2 + x^2 + 2^2 + 3^2 = 3^3$
 $4 + x^2 + 4 + 9 = 33$
 $x^2 = 33 - 17$
 $x^2 = 16$
 $x = 4$

Cevap: D

4.

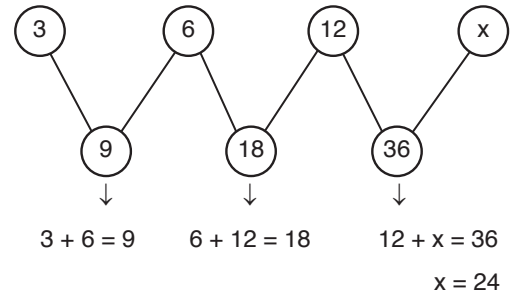

Cevap: A

5.

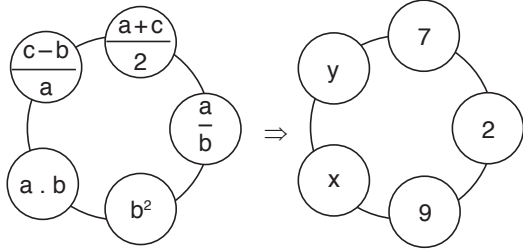

$$\bullet \frac{a+c}{2} = 7 \Rightarrow a+c = 14 \Rightarrow c = 8$$

$$\bullet \frac{a}{b} = 2 \Rightarrow a = 2b = 6$$

$$\bullet b^2 = 9 \Rightarrow b = 3$$

$$x = a.b = 6.3 = 18, \quad y = \frac{c-b}{a} = \frac{8-3}{6} = \frac{5}{6}$$

$$x.y = 18 \cdot \frac{5}{6} = 15 \text{ bulunur.}$$

Cevap: B

7.

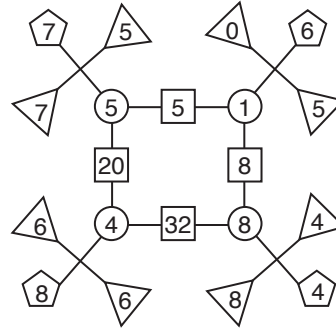

$$K = 32$$

$$L = 0$$

$$M = 4$$

- (Üçgen içlerini topla) – (Beşgen içi) = Daire içi
 - İki daire içi çarpımı = kare içi
- $$K + L + M = 32 + 0 + 4 = 36$$

Cevap: E

TASARI EĞİTİM YAYINLARI

8.

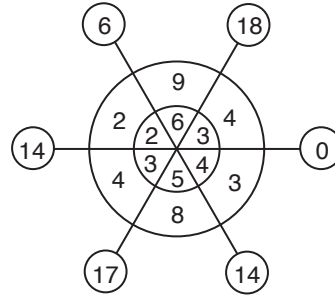

$$K = 17 \text{ ve } L = 4$$

$$K + L = 17 + 4 = 21$$

Cevap: A

6.

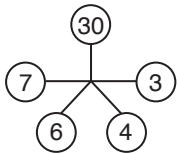

$$(7.6) - (4.3) = 30$$

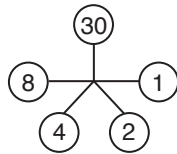

$$(8.4) - (2.1) = 30$$

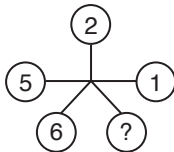

$$(5.6) - (x.1) = 2$$

$$30 - x = 2$$

$$28 = x$$

Cevap: E

9.

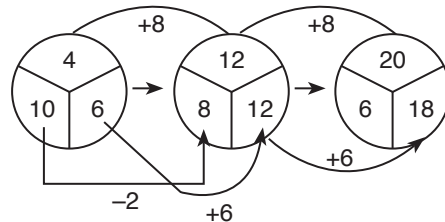

Cevap: C

10.

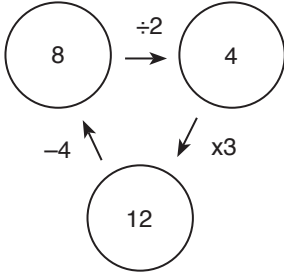

A = 8 olur.

Cevap: E

11.

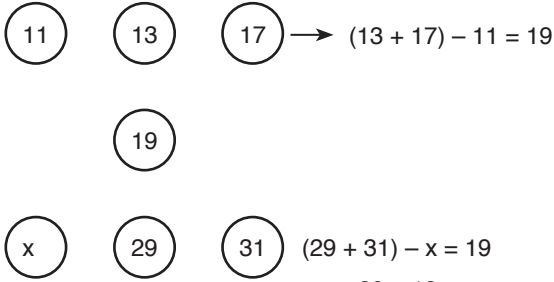

$$\begin{aligned} 60 - 19 &= x \\ 41 &= x \end{aligned}$$

Cevap: C

12.

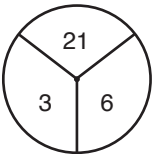

$$(3.6) + 3 = 21$$

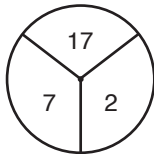

$$(7.2) + 3 = 17$$

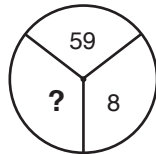

$$(x.8) + 3 = 59$$

$$x.8 = 56$$

$$x = 7$$

Cevap: B

13.

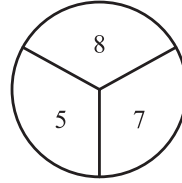

$$\frac{8+7}{5} = 3$$

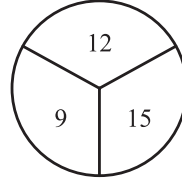

$$\frac{12+15}{9} = 3$$

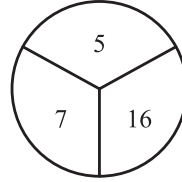

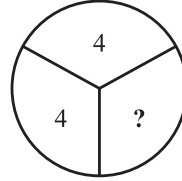

$$\frac{5+16}{7} = 3$$



$$\frac{4+x}{4} = 3 \Rightarrow \underline{x=8}$$

Cevap: B

14.  → İçindeki sayının rakamları çarpımı

 → İçindeki sayının rakamları toplamı

 → İçindeki sayının karesi

$$\begin{array}{ccc} \begin{array}{c} \text{○} \\ \text{□} \\ \text{△} \\ \text{7} \end{array} & + & \begin{array}{c} \text{□} \\ \text{△} \\ \text{○} \\ \text{24} \end{array} = ? \\ \downarrow & & \downarrow \\ 7^2 = 49 \text{ (üçgen)} & & 2.4 = 8 \text{ (daire)} \\ 4 + 9 = 13 \text{ (kare)} & & 8^2 = 64 \text{ (üçgen)} \\ 1.3 = 3 \text{ (daire)} & & 6 + 4 = 10 \text{ (kare)} \end{array}$$

O halde

$$3 + 10 = 13$$

Cevap: D

16. Üçgende içindeki sayı ile kenar sayısının çarpımı

$$\begin{array}{c} \text{△} \\ \text{2} \end{array} \rightarrow 3.2 = 6$$

$$\begin{array}{c} \text{△} \\ \text{3} \end{array} \rightarrow 3.3 = 9$$

Karede içindeki sayı ile kenar sayısının bölümü

$$\begin{array}{c} \text{□} \\ \text{8} \end{array} \rightarrow \frac{8}{4} = 2$$

$$\begin{array}{c} \text{□} \\ \text{12} \end{array} \rightarrow \frac{12}{4} = 3$$

$$\begin{array}{c} \text{△} \\ \text{1} \end{array} + \begin{array}{c} \text{□} \\ \text{4} \end{array} \\ \downarrow \quad \downarrow \\ 1.3 + \frac{4}{4} = 3 + 1 \\ = 4$$

Cevap: A

15. Taralı şekillerde içindeki sayının rakamlarını topla kenar sayısını çıkar.

$$\begin{array}{c} \text{10} \end{array} \rightarrow (1 + 0) - 6 = -5$$

Taralı olmayan şekillerde içindeki sayının rakamlarını topla kenar sayısı ile çarp.

$$\begin{array}{c} \text{62} \end{array} \rightarrow (6 + 2).3 = 24$$

$$\begin{array}{c} \text{89} \end{array} \rightarrow ((8 + 9) - 4) = \begin{array}{c} \text{13} \end{array} \\ \downarrow \\ (1 + 3).4 = 16$$

Cevap: D

17.

$$\begin{array}{c} \text{-13} \\ \text{12} \quad \text{14} \end{array} \\ (12 + 14) \div (12 - 14) \\ 26 \div (-2) = -13$$

$$\begin{array}{c} \text{3} \\ \text{10} \quad \text{5} \end{array} \\ (10 + 5) \div (10 - 5) \\ 15 \div 5 = 3$$

$$\begin{array}{c} \text{x} \\ \text{22} \quad \text{24} \end{array} \\ (22 + 24) \div (22 - 24) \\ 46 \div (-2) \\ X = -23$$

Cevap: A

18.

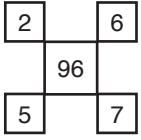

$$(2 + 6) \cdot (5 + 7)$$

$$= 8 \cdot 12$$

$$= 96$$

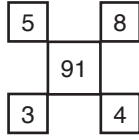

$$(5 + 8) \cdot (3 + 4)$$

$$= 13 \cdot 7$$

$$= 91$$

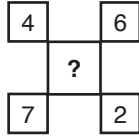

$$(4 + 6) \cdot (7 + 2)$$

$$= 10 \cdot 9$$

$$= 90 \text{ bulunur.}$$

Cevap: D

19.

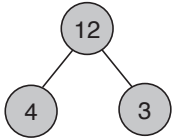

$$4 \cdot 3 = 12$$

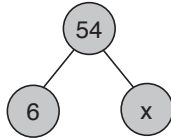

$$6 \cdot x = 54 \Rightarrow x = 9$$

Cevap: A

20.

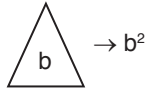
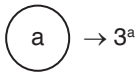
 \rightarrow  \rightarrow

$$(3^x)^2 = 81 = 3^4$$

$$2x = 4 \Rightarrow x = 2$$

Cevap: B