

## ÇÖZÜMLERİ

1. i)  $10 + 5 = 15$   
 $10 - 5 = 5$   $\left. \vphantom{\begin{matrix} 10 + 5 = 15 \\ 10 - 5 = 5 \end{matrix}} \right\} 15.5 = 75$

iii)  $5 + 4 = 9$   
 $5 - 4 = 1$   $\left. \vphantom{\begin{matrix} 5 + 4 = 9 \\ 5 - 4 = 1 \end{matrix}} \right\} 9.1 = 9$

ii)  $9 + 1 = 10$   
 $9 - 1 = 8$   $\left. \vphantom{\begin{matrix} 9 + 1 = 10 \\ 9 - 1 = 8 \end{matrix}} \right\} 10.8 = 80$

iv)  $7 + 2 = 9$   
 $7 - 2 = 5$   $\left. \vphantom{\begin{matrix} 7 + 2 = 9 \\ 7 - 2 = 5 \end{matrix}} \right\} 9.5 = 45$

2.  $4^1 = 4$

$4^2 = 4 \omega 4 = 5$

$4^3 = 5 \omega 4 = 3$

$4^4 = 3 \omega 4 = 4$

$4^5 = 4 \omega 4 = 5$

$4^{41} = (4^4)^{10} \omega 4 = 4 \omega 4 = 5$

3. i)

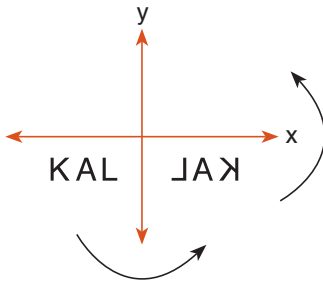

ii)

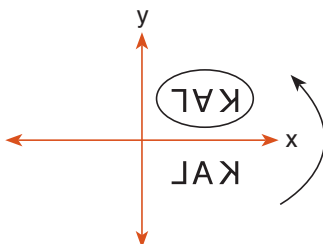

Cevap: A

4.

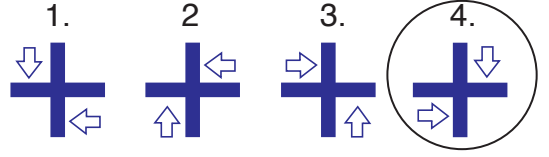

Cevap: C

Cevap: A

5.

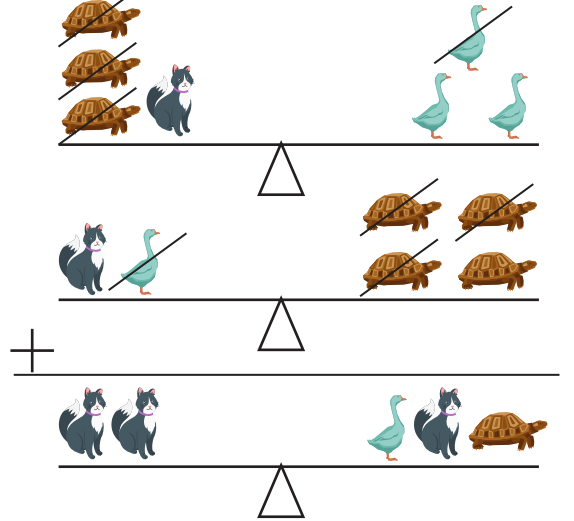

Cevap: C

Cevap: C

6.

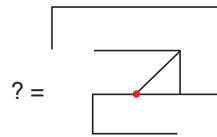

Cevap: D

Cevap: C

7.

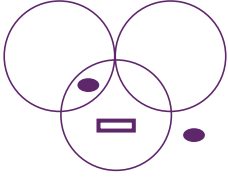

Cevap: E

8.  $35624 \Rightarrow 96482$   $2 \Rightarrow \textcircled{8}$   
 $72653 \Rightarrow 78469$   $3 \Rightarrow \textcircled{9}$   
 $65372 \Rightarrow 46978$   $4 \Rightarrow \textcircled{2}$   
 $42356 \Rightarrow 28964$   $5 \Rightarrow \textcircled{6}$   
 $53427 \Rightarrow 69287$   $6 \Rightarrow \textcircled{4}$   
 $7 \Rightarrow \textcircled{7}$   
 $8 \Rightarrow \textcircled{2}$   
 $9 \Rightarrow \textcircled{3}$

O halde sayımız

 $549723 \Rightarrow \boxed{623789}$ 

9. Önce  $\textcircled{O}$  yapılır.  
 TMXRCK, sonra  $\triangle$  yapılır.  
 KMCRXT olur.

10.  $x \otimes y = x + 3y$   
 $x \odot y = x \cdot y$   
 $(5 \otimes 1) \odot (1 \otimes 1)$   
 $(5 + 3 \cdot 1) \odot (1 + 3 \cdot 1) = 8 \odot 4 = 8 \cdot 4$   
 $= 32$

Cevap: B

11.

$$\begin{array}{r} 2x - y + 4z = 33 \\ -2/ \quad 3z + 2x + y = 24 \\ \hline 4y + 3z + 3x = 28 \\ 2x - y + 4z = 33 \\ \hline -6z - 4x - 2y = -48 \\ + \quad 4y + 3z + 3x = 28 \\ \hline x + y + z = 13 \end{array}$$

Cevap: E

12.  $a + b = 10$ 

$a \cdot c = 36, \quad b \cdot c = 54$

$c(a + b) = 90$

$10$

$\boxed{c = 9}$

$a = 4 \text{ ve } b = 6$

Cevap: E

Cevap: C 13.

$$7^2 = 49$$

$$4^3 = 64$$

$$2^4 = 16$$

$7^2 + 4^2 + 2^2 = 129$

Cevap: E

Cevap: D

14.

$$3 \cdot 2 + 4 \cdot 1 = 10$$

$$6 \cdot 5 + 5 \cdot 4 = 50$$

$$7 \cdot 3 + 8 \cdot 4 = 21 + 32 = 53$$

Cevap: D

15. I II  
Kenar değerleri topla  
Kenar bağıntısına böl  
 $\frac{8+3+7+2}{4} = 5$   $\frac{6+4+7+8+5}{5} = 6$

III  
 $\frac{9+7+8+9+7+8}{6} = 8$

Cevap: A

16.  $8 \text{ kg} \cdot 4 \text{ br} + 3 \text{ kg} \cdot 7 \text{ br} = 15 \text{ kg} \cdot 3 \text{ br} + ? \cdot 2 \text{ br}$   
 $32 + 21 = 45 + 2 \cdot ?$   
 $53 = 45 + 2 \cdot ?$   
 $\Rightarrow ? = 4 \text{ kg}$

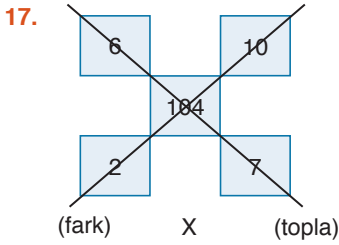

$(10 - 2) \times (6 + 7) = 140$   
 $(10 - 2) \times (17 + 5) = 8 \cdot 22 = 176$

18. Son satırı



Cevap: E

19. Eksik olan parça A'dır.

Cevap: A

20. ~ → saat yönünde 1 kenar ilerliyor.

● → Saat yönünde 2 köşe ilerliyor.

< → Saat yönünün tersi 1 köşe ilerliyor.

Cevap: C

Cevap: B

TASARI EĞİTİM YAYINLARI



Cevap: C

22. (Mavilerin kenar sayısının toplamının 2 katı) - (Beyazların kenar sayıları toplamı)

$2 \cdot 6 - (3 + 4) = 12 - 7 = 5$

Cevap: C

23.

45° yükseliyor her defasında.

Cevap: D

24.

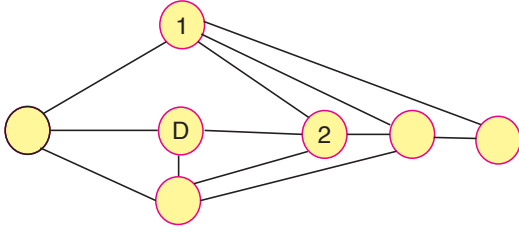

1 → F

2 → B

Cevap: B

25.

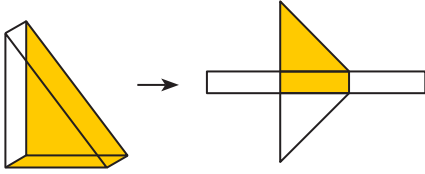

Cevap: B

26. Çember dışındaki ● ifadelerin farkı çember içine ya da dışına yazılıyor. İçteki daireler fazla ise içe, dıştakiler fazla ise dışa yazılıyor.



Cevap: B

27.

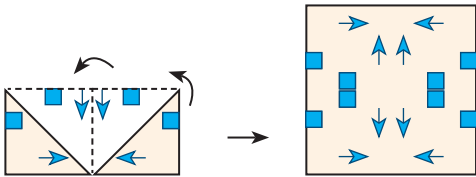

Cevap: C

28. E seçeneği verilen şekille özdeşdir.

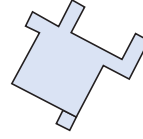

Cevap: E

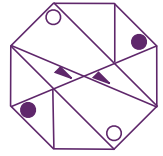
29.  $\frac{360}{8} = 45 \rightarrow$  dış açısı $\frac{225}{45} = 5$  defa dönmeli

Cevap: E

30. Dikey kibrit sayısı  $7 \cdot 3 = 21$ Yatay kibrit sayısı  $+ 6 \cdot 4 = 24$ 

45 tane yapar.

Cevap: D

31. ifadesi olarak 4 tane yan yana koyuyor.

Bundan da 4 tane yan yana koyarsak A olur.

Cevap: A

$$\left. \begin{array}{l} 2 \times 2\text{'lik} \rightarrow 6 \\ 3 \times 3\text{'lük} \rightarrow 1 \\ 1 \times 1\text{'lik} \rightarrow 15 \end{array} \right\} 22$$

Cevap: C

33. Küpü kapatırsak

$$6 \rightarrow 1$$

$$3 \rightarrow 2$$

$$5 \rightarrow 4 \quad \text{karşılıklı gelen yüzler bunlar olmalı.}$$

Şıklar incelendiğinde

$$B \text{ şıkkı} \rightarrow 1 \text{ ile } 6 \text{ yan yana}$$

$$C \text{ şıkkı} \rightarrow 2 \text{ ile } 3 \text{ yan yana}$$

$$D \text{ şıkkı} \rightarrow 4 \text{ ile } 5 \text{ yan yana}$$

$$E \text{ şıkkı} \rightarrow 2 \text{ ile } 3 \text{ yan yana}$$

Cevap: A

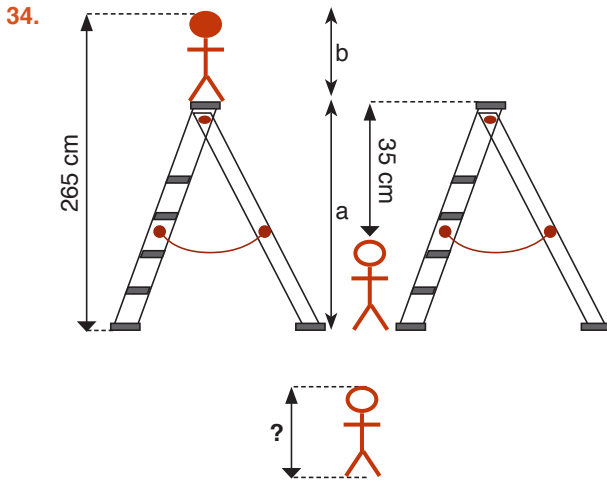

$$\begin{array}{r} a + b = 265 \\ - a - b = 35 \\ \hline 2b = 230 \\ b = 115 \end{array}$$

Cevap: D

35. Küpler sayıldığında 40 tane gelir.

Cevap: B

36.

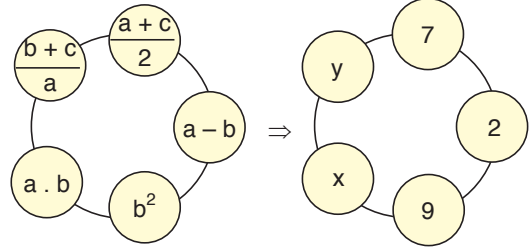

$$b^2 = 9 \Rightarrow \boxed{b = 3}$$

$$a - b = 2 \Rightarrow \boxed{a = 5}$$

$$\frac{a+c}{2} = 2 \Rightarrow \boxed{c = 1}$$

$$\frac{b+c}{a} = y \Rightarrow \frac{4}{5} = y$$

$$a \cdot b = x \Rightarrow x = 15$$

$$\sqrt{\frac{4}{5}} \cdot 15 = 2\sqrt{3}$$

Cevap: A

37.

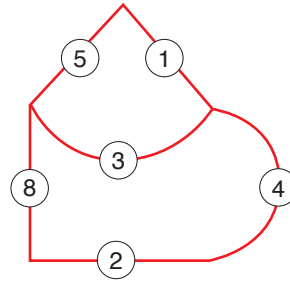

$$\begin{array}{r} \text{---} \\ \text{---} \\ \text{---} \end{array} = 1541$$

$$\begin{array}{r} \text{---} \\ \text{---} \\ \text{---} \end{array} = 11612$$

$$\begin{array}{r} \text{---} \\ \text{---} \\ \text{---} \end{array} = 2485$$

Cevap: E

38.

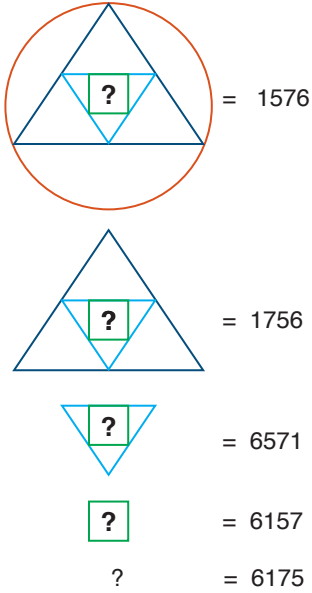

Cevap: C

39.

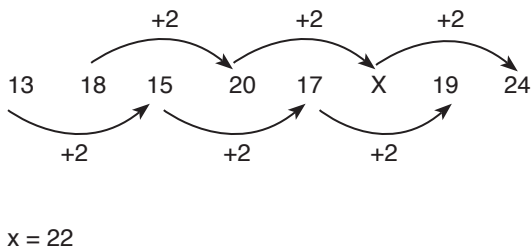

Cevap: D

40.

+	x ▲	x x ▲ ▲	○ △
t ●		○○○○ ○○○○	▲▲▲
○			
z △	○○○○ ○○○○		

$\text{▲▲} = \text{▲} + \text{▲} \Rightarrow \text{●} + \text{△} = ?$   
 $t + z = ?$

- ▲ = x
- = y
- △ = z
- = t olsun.

$$\begin{array}{r}
 x + 2x = 8y \\
 - / x + y + z = 3x \\
 + \quad z + x = 9y \\
 \hline
 3x + y = 17y - 3x \\
 6x = 18y \\
 x = 3y \Rightarrow z = 6y \Rightarrow t = 2y \\
 t + z = 8y = \text{▲▲} \text{ ○ ○}
 \end{array}$$

Cevap: E

$$\begin{aligned}
 41. \quad & \left(4 \cdot \frac{1}{2}\right) \frac{1}{4} - \frac{1}{2} \\
 & = (4 \cdot 2) \frac{1}{4} - \frac{1}{2} \\
 & = 8 \cdot \frac{1}{4} - \frac{1}{2} \Rightarrow 2 - \frac{1}{2} = \frac{3}{2}
 \end{aligned}$$

Cevap: E

$$\begin{aligned}
 42. \quad & (0,000027)^{\frac{11}{3}} \cdot 10^{22} \\
 & = (27 \cdot 10^{-6})^{\frac{11}{3}} \cdot 10^{22} \\
 & = (3^3 \cdot 10^{-6})^{\frac{11}{3}} \cdot 10^{22} \\
 & = (3^3)^{\frac{11}{3}} \cdot (10^{-6})^{\frac{11}{3}} \cdot 10^{22} \\
 & = 3^{11} \cdot 10^{-22} \cdot 10^{22} = 3^{11}
 \end{aligned}$$

Cevap: E

$$\begin{aligned}
 43. \quad & \sqrt{0,006} \cdot \sqrt{0,08} \cdot \sqrt{0,3} \\
 & = \sqrt{0,006 \cdot 0,08 \cdot 0,3} = \sqrt{0,000144} \\
 & = \sqrt{\frac{144}{1000000}} = \frac{12}{1000} \\
 & = 0,012
 \end{aligned}$$

Cevap: D

$$\begin{aligned}
 44. \quad & \left. \begin{array}{l} a^b = b^a \\ 2a = 3b \rightarrow a = 3k \\ \qquad \qquad \qquad b = 2k \\ (3k)^{2k} = (2k)^{3k} \end{array} \right\} \\
 & 3k = (2k)^{\frac{3k}{2k}} \\
 & 3k = (2k)^{\frac{3}{2}} \\
 & 9k^2 = (2k)^3 \\
 & 9k^2 = 8k^3 \\
 & \boxed{\frac{9}{8} = k} \\
 & a = 3k = 3 \cdot \frac{9}{8} = \frac{27}{8}
 \end{aligned}$$

Cevap: D

$$\begin{aligned}
 45. \quad & -2 \left/ \begin{array}{l} \frac{2}{x} + \frac{5}{y} = 6 \\ \frac{2}{y} + \frac{10}{x} = 8 \\ -\frac{4}{x} - \frac{10}{y} = -12 \end{array} \right. \\
 & + \frac{10}{y} + \frac{50}{x} = 40 \\
 \hline
 & \frac{46}{x} = 28 \\
 & x = \frac{46}{28} = \frac{23}{14}
 \end{aligned}$$

Cevap: C

$$\begin{aligned}
 46. \quad & \sqrt{11 + \sqrt{21}} - \sqrt{11 - \sqrt{21}} \\
 & = \frac{\sqrt{22 + 2\sqrt{21}}}{\sqrt{2}} - \frac{\sqrt{22 - 2\sqrt{21}}}{\sqrt{2}} \\
 & = \frac{\sqrt{21} + 1}{\sqrt{2}} - \frac{\sqrt{21} - 1}{\sqrt{2}} = \frac{2}{\sqrt{2}} = \frac{2\sqrt{2}}{2} = \sqrt{2}
 \end{aligned}$$

Cevap: D

$$\begin{aligned}
 47. \quad & a - b - 1 = 0 \Rightarrow a - b = 1 & 2a - 2b = 2 \\
 & 3a + 2b - 13 = 0 \Rightarrow 3a + 2b = 13 & + \quad 3a + 2b = 13 \\
 & & \hline
 & & 5a = 15 \\
 & & \boxed{a = 3} \\
 & & a - b = 1 \\
 & & \boxed{b = 2} \\
 & a + b = 3 + 2 = 5
 \end{aligned}$$

Cevap: A

$$48. ax = by = cz = \frac{1}{6}$$

$$\frac{a}{x} = \frac{b}{y} = \frac{c}{z} = \frac{1}{6}$$

$$\frac{a+b+c}{\frac{1}{x} + \frac{1}{y} + \frac{1}{z}} = \frac{1}{6}$$

$$\frac{30}{\frac{1}{x} + \frac{1}{y} + \frac{1}{z}} = \frac{1}{6} \Rightarrow 30 \cdot 6 = \frac{1}{x} + \frac{1}{y} + \frac{1}{z}$$

$$\Rightarrow 180 = \frac{1}{\left(\frac{x}{yz}\right)} + \frac{1}{\left(\frac{y}{xz}\right)} + \frac{1}{\left(\frac{z}{xy}\right)}$$

$$\Rightarrow 180 = \frac{yz + xz + xy}{x \cdot y \cdot z}$$

$$\Rightarrow 180 = \frac{yz + xz + xy}{2}$$

$$\Rightarrow 360 = yz + xz + xy$$

Cevap: D

$$49. |x+1| \leq 2 \quad \text{ve} \quad |x-1| < 5$$

$$-2 \leq x+1 \leq 2 \quad -5 < x-1 < 5$$

$$-3 \leq x \leq 1 \quad -4 < x < 6$$

$$A = \{-3, -2, -1, 0, 1\} \quad B = \{-3, -2, -1, 0, 1, 2, 3, 4, 5\}$$

O halde  $s(A \cap B) = 5$  olur.

Cevap: B

$$50. (a^2 - 64)^{1991} = 0, \quad (a-1)^{2000} = 0, \quad (a-3)^{1990} = 0$$

$$a^2 = 64 \quad a = 1 \quad a = 3$$

$$a = 8 \text{ ve } a = -8 \quad \text{\textit{\textbf{çift katlı kök}} \quad \text{\textit{\textbf{çift katlı kök}}}$$

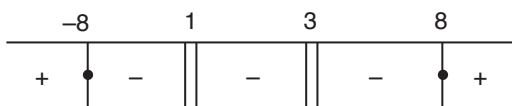

$$\text{\textit{\textbf{Ç.K}}} = [-8, 8] - \{1, 3\}$$

Cevap: D

$$51. \binom{10}{0} + \binom{10}{1} + \binom{10}{2} + \binom{10}{3} + \dots + \binom{10}{10} = 2^{10}$$

$$\left. \begin{aligned} \binom{10}{2} + \binom{10}{4} + \dots + \binom{10}{10} &= x \\ + \binom{10}{3} + \binom{10}{5} + \dots + \binom{10}{9} &= y \end{aligned} \right\} \begin{array}{l} \text{iki denklemi} \\ \text{toplarsak} \end{array}$$

$$\binom{10}{2} + \binom{10}{3} + \binom{10}{4} + \dots + \binom{10}{9} + \binom{10}{10} = x + y$$

$$x + y = 2^{10} - \left[ \binom{10}{0} + \binom{10}{1} \right] = 1024 - 11 = 1013$$

$$\Rightarrow x + y - 1 \text{ yazılırsa; } 1013 - 1 = 1012$$

Cevap: B

$$52. A = \{a, b, e, de\} \quad \text{O halde } A \setminus (B \cap C)$$

$$B \cap C = \{e, m\} \quad = \{a, b, d\} \text{ olur.}$$

Cevap: D

$$53. f\left(\frac{2x}{3} + 2\right) = \frac{x}{3} - 4, \quad g(x) = \frac{x-5}{2}$$

$$(f^{-1} \circ g)(3) \Rightarrow f^{-1}(g(3)) = f^{-1}(-1) = ?$$

$$g(3) = \frac{3-5}{2} = -1$$

$$f^{-1}\left(\frac{x}{3} - 4\right) = \frac{2x}{3} + 2 \quad x = 9 \text{ için} \quad f^{-1}(-1) = 8$$

Cevap: B



54.

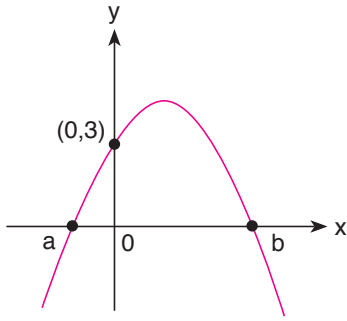

$$y = -x^2 + mx + 3$$

$a = n$  ise  $b = n + 4$  olur, kökler çarpımı  $= a \cdot b = -3$

$$n \cdot (n + 4) = -3$$

$$\boxed{n = -1}$$
 olur.

$$\Rightarrow \text{Kökler toplamı} = a + b = \frac{-m}{-1}$$

$$= -1 + 3 = m$$

$$\boxed{m = 2}$$

Cevap: E

55.  $a_1 = 4$

$$a_{n+1} = a_n + 3$$

$$n = 1 \text{ için } \cancel{a_2} = a_1 + 3$$

$$n = 2 \text{ için } \cancel{a_3} = \cancel{a_2} + 3$$

$$n = 3 \text{ için } \cancel{a_4} = \cancel{a_3} + 3$$

⋮

$$n = 19 \text{ için } + \cancel{a_{20}} = \cancel{a_{19}} + 3$$

$$a_{20} = a_1 + 3 \cdot 19$$

$$a_{20} = 4 + 57 \text{ ise } \boxed{a_{20} = 61}$$
 olur.

Cevap: B

56.  $\frac{f(x-3)}{f(x+2)} = \frac{(x-3) \cdot 5^{x-3}}{(x+2) \cdot 5^{x+2}} = 5^{-3}$

$$\Rightarrow \frac{(x-3)}{(x+2)} \cdot 5^{-5} = 5^{-3} \Rightarrow \frac{x-3}{x+2} = \frac{1}{25}$$

$$25x - 75 = x + 2$$

$$24x = 77$$

$$\boxed{x = \frac{77}{24}}$$

Cevap: D

TASARI EĞİTİM YAYINLARI

57.  $P(x) = 4 \cdot x^{\frac{13}{m-5}} - 6 \cdot x^{25-2m} + 4x^{13} + 5x^{10} - 4$

$$\frac{13}{m-5} \in \mathbb{Z}^+ \quad 25 - 2m \geq 0 \quad \text{olmalıdır.}$$

$$m = 6 \quad 2m \leq 25$$

$$6$$

O halde  $m = 6$  için

$$P(x) = 4 \cdot x^{13} - 6 \cdot x^{13} + 4 \cdot x^{13} + 5 \cdot x^{10} - 4$$

$$P(x) = 2 \cdot x^{13} + 5 \cdot x^{10} - 4$$

O halde başkatsayı 2 olur.

$$\Rightarrow P(1) = 2 \cdot 1^{13} + 5 \cdot 1^{10} - 4$$

$$= 2 + 5 - 4$$

$$= 3$$

Cevap: A

$$\begin{aligned}
 58. \quad \frac{\frac{3}{4!} + \frac{5}{5!}}{\frac{6}{6!}} &= \frac{\frac{3}{24} + \frac{5}{120}}{\frac{6}{720}} \\
 &= \frac{\frac{3}{24} + \frac{1}{24}}{\frac{1}{120}} = \frac{4}{24} \cdot \frac{120}{1} \\
 &= 20 \text{ bulunur.}
 \end{aligned}$$

Cevap: C

$$\begin{aligned}
 59. \quad |a| &= b + 3 \text{ ise} \\
 a &= b + 3 \text{ veya } a = -b - 3 \text{ olmalıdır.} \\
 \text{Bu iki durumu diğer eşitlikte yerine yazalım} \\
 a &= b + 3 \text{ için } |a - b| = b + 9 \\
 |b + 3 - b| &= b + 9 \\
 3 &= b + 9 \Rightarrow b = -6 \text{ olup} \\
 \text{bu değer } |a| &= b + 3 \text{ eşitliğinde yazıldığında} \\
 |a| &= -3 \text{ olamaz.}
 \end{aligned}$$

$$\begin{aligned}
 \bullet \quad a &= -b - 3 \text{ için} \\
 |-b - 3 - b| &= b + 9 \\
 \begin{array}{l} \swarrow \quad \searrow \\ -2b - 3 = b + 9 \quad -2b - 3 = -b - 9 \\ -12 = 3b \quad \quad \quad 6 = b \text{ (sağlar)} \\ -4 = b \\ \text{(sağlamaz)} \end{array}
 \end{aligned}$$

b = 6 için

$$\bullet \quad |a| = b + 3 \Rightarrow |a| = 6 + 3 = 9$$

a = 9 veya a = -9

$$\begin{array}{l}
 a = 9 \text{ için } |a - b| = b + 9 \\
 b = 6 \quad |9 - 6| = 6 + 9 \\
 \quad \quad \quad 3 \neq 15 \\
 \left. \begin{array}{l} a = -9 \\ b = 6 \text{ için sağlar.} \\ \text{O halde} \\ a \cdot b = -9 \cdot 6 = -54 \end{array} \right\}
 \end{array}$$

bulunur.

Cevap: A

$$\begin{aligned}
 60. \quad A &= 2\sqrt{5} = \sqrt{4 \cdot 5} = \sqrt{20} \\
 4 &< A < 5 \\
 B &= 3\sqrt{3} = \sqrt{9 \cdot 3} = \sqrt{27} \\
 5 &< B < 6 \\
 C &= \sqrt{10} \\
 3 &< C < 4 \\
 \text{O halde } C &< A < B \text{ dir.}
 \end{aligned}$$

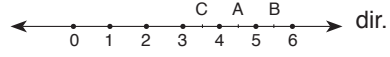

Cevap: B

$$\begin{aligned}
 61. \quad a - \sqrt{a} &= 7 \Rightarrow \frac{a^2 - \sqrt{a} + a - a\sqrt{a}}{a + 1} \\
 &= \frac{a(a + 1) - \sqrt{a}(1 + a)}{a + 1} \\
 &= \frac{(a + 1) \cdot (a - \sqrt{a})}{a + 1} \\
 &= a - \sqrt{a} = 7
 \end{aligned}$$

Cevap: B

$$\begin{array}{ll}
 62. \quad \text{i)} & a + b \cdot c = 9 \\
 & + \quad b + a \cdot c = 3 \\
 \hline
 & a + b + c(a + b) = 12 \\
 & (a + b)(c + 1) = 12 \\
 \text{ii)} & a + b \cdot c = 9 \\
 & + \quad b + a \cdot c = 3 \\
 \hline
 & (a - b) + c(b - a) = 6 \\
 & (a - b)(1 - c) = 6 \\
 & (a - b)(c - 1) = -6
 \end{array}$$

i ve ii'den bulduğumuz denklemleri taraf tarafa çarparsak,

$$\begin{array}{l}
 (a + b)(c + 1) = 12 \\
 \times \quad (a - b)(c - 1) = -6 \\
 \hline
 (a^2 - b^2)(c^2 - 1) = -72 \text{ olur.}
 \end{array}$$

Cevap: A

$$63. \frac{2x(5-x)+12}{x(2-x)+3} : \left(1 + \frac{3}{3-x}\right)$$

$$\frac{10x-2x^2+12}{2x-x^2+3} : \left(\frac{3-x+3}{3-x}\right)$$

$$\frac{-(2x^2-10x-12)}{-(x^2-2x-3)} \cdot \frac{3-x}{6-x}$$

$$\frac{2(x^2-5x-6)}{x^2-2x-3} \cdot \frac{x-3}{x-6}$$

$$\frac{2 \cdot \cancel{(x-6)} \cdot (x+1)}{\cancel{(x-3)} \cdot (x+1)} \cdot \frac{\cancel{x-3}}{\cancel{x-6}} = 2$$

Cevap: B

$$64. a \cdot b \cdot c = 2(a+b) \text{ ve } a = k \text{ ise } b = 2k \text{ dir.}$$

$$2k^2 \cdot c = 2 \cdot 3k$$

$$c = \frac{3}{k}$$

$$3k + \frac{k}{3} = \frac{10k}{3} = \frac{30}{3} \Rightarrow k = 9, c = \frac{3}{9} = \frac{1}{3}$$

Cevap: C

$$65. \bullet f(x) \text{ fonksiyonunu bulabilmek için;}$$

$$\frac{x-2}{3} \text{ 'ün tersi } 3x+2 \text{ ifadesini } x \text{ gördüğümüz}$$

yere yazarsak

$$f(x) = 5(3x+2) - 25 = 15x - 15$$

$$\bullet f(a) < 14a$$

$$15a - 15 < 14a$$

$a < 15$  ve  $a$ 'nın en büyük değeri 14 olur.

Cevap: C

$$66. \left(1 - \frac{1}{3}\right) \cdot \left(2 - \frac{2}{4}\right) \cdot \left(3 - \frac{3}{5}\right) \cdot \dots \cdot \left(9 - \frac{9}{11}\right)$$

$$= \left(1 - \frac{1}{3}\right) \cdot 2 \cdot \left(1 - \frac{1}{4}\right) \cdot 3 \cdot \left(1 - \frac{1}{5}\right) \cdot \dots \cdot 9 \cdot \left(1 - \frac{1}{11}\right)$$

$$= \frac{2 \cdot 3 \cdot 4 \cdot \dots \cdot 9}{9!} \cdot \left(1 - \frac{1}{3}\right) \cdot \left(1 - \frac{1}{4}\right) \cdot \left(1 - \frac{1}{5}\right) \cdot \dots \cdot \left(1 - \frac{1}{11}\right)$$

$$= 9! \cdot \frac{2}{3} \cdot \frac{3}{4} \cdot \frac{4}{5} \cdot \dots \cdot \frac{10}{11}$$

$$= 9! \cdot \frac{2}{11}$$

Cevap: D

$$67. 0 < x < 1 \quad x = \frac{1}{4} \text{ alalım.}$$

$$a = x^2 = \left(\frac{1}{4}\right)^2 = \frac{1}{16}$$

$$b = \frac{1}{x} = \frac{1}{\frac{1}{4}} = 4$$

$$c = \frac{1}{\sqrt{x}} = \frac{1}{\sqrt{\frac{1}{4}}} = \frac{1}{\frac{1}{2}} = 2$$

$$a < c < b$$

Cevap: B

68.

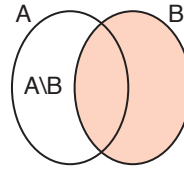

$$s(B) = 5 \cdot s(A \setminus B) \text{ olduğundan}$$

$$s(A \setminus B) = x \text{ ise } s(B) = 5x \text{ olur.}$$

$$s(A \cup B) = 3 \cdot s(A \setminus B) + 15$$

$$s(A \cup B) = 3x + 15 \text{ tir.}$$

$$A \cup B \text{ kümesinin eleman sayısı } s(B) + s(A \setminus B) = 5x + x = 6x$$

$$6x = 3x + 15$$

$$3x = 15 \Rightarrow x = 5$$

$$B \text{ kümesinin eleman sayısı } s(B) = 5x = 5 \cdot 5$$

$$= 25 \text{ bulunur.}$$

Cevap: D

69. Elma Armut  
 $x$   $60-x$  olur.  
 $\Rightarrow x \cdot \frac{7}{100} + (60-x) \cdot \frac{5}{100} = 3,5$   
 $\Rightarrow \frac{7x + 300 - 5x}{100} = 3,5$   
 $\Rightarrow 2x + 300 = 350$

$x = 25$  olur. Toplam elma sayısı olur.

Sağlam elma =  $25 - 25 \cdot \frac{7}{100}$   
 $= 25 - 1,75$   
 $= 23,25$  olur.

Cevap: B

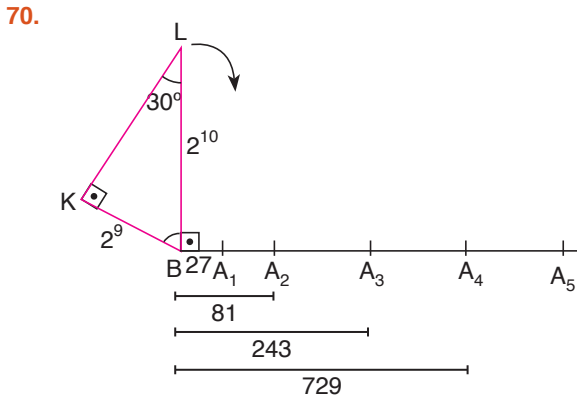

$$\left. \begin{array}{l} n = 1 \text{ için } |BA_1| = 3^3 \\ n = 2 \text{ için } |BA_2| = 3^4 = 81 \\ n = 3 \text{ için } |BA_3| = 3^5 = 243 \\ n = 4 \text{ için } |BA_4| = 3^6 = 729 \end{array} \right\} |BL| = 2^{10} = 1024$$

$n = 5$  için L noktasının konumu:  $A_4 < L < A_5$  olur.

Cevap: E

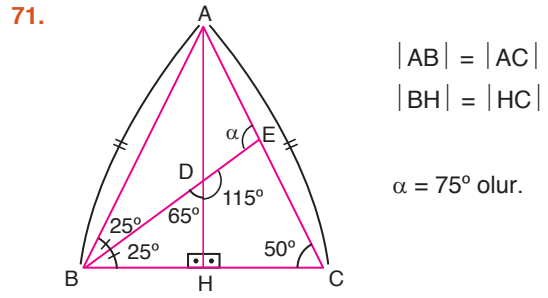

Cevap: E

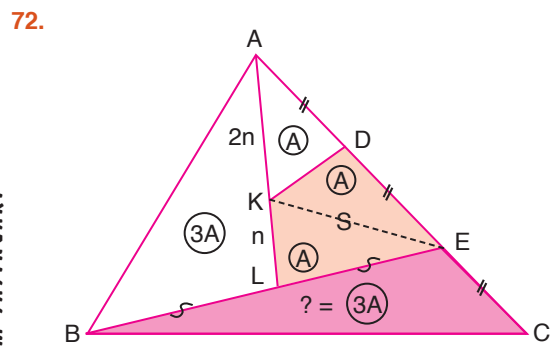

$2A = S$  O halde  $? = 3.A$

$$A = \frac{S}{2} \quad ? = \frac{3}{2}S$$

Cevap: C

73. AB uzantısı ve EF uzantısı alınırsa  $x = 25^\circ$  olduğu görülür.

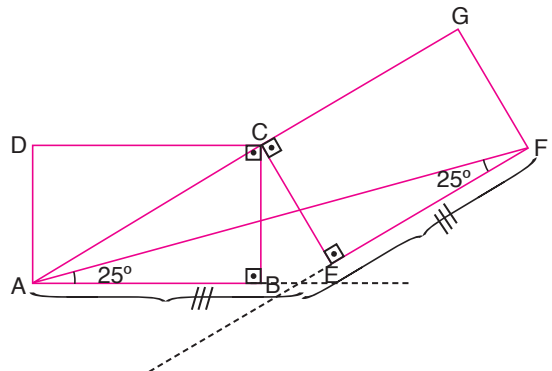

Cevap: C

74.

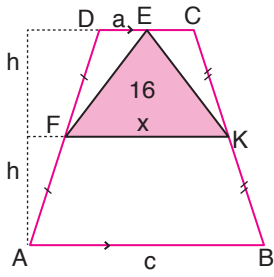

$$\text{Orta taban} = x = \frac{a+c}{2}$$

$$A(\triangle EFK) = \frac{x \cdot h}{2} = 16 \quad x \cdot h = 32$$

$$\text{Tüm alan} = 2 \cdot x \cdot h = 2 \cdot 32 = 64 \text{ cm}^2$$

Cevap: B

75.

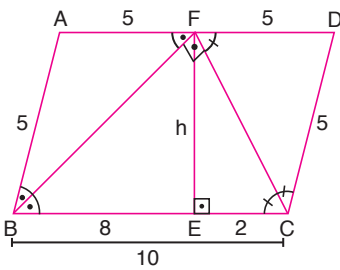

$$AD = BC = 10 \text{ olur.}$$

$$h^2 = 8 \cdot 2$$

$$h^2 = 16 \rightarrow h = 4 \text{ olur.}$$

Cevap: A

76.

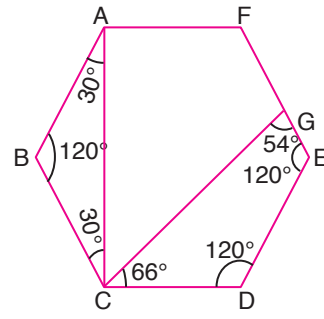

$$\text{Altıgenin bir iç açısı, } \frac{360}{6} = 60 \rightarrow \text{dış açısı}$$

$$180 - 60 = 120 \text{ iç açısı}$$

ABC ikizkenar üçgen

$$120 + 120 + 54 = 294$$

$$360 - 294 = 66 \rightarrow \widehat{GCD} \text{ açısı}$$

$$120 - (66 + 30) = m(\widehat{ACG}) = 24^\circ$$

$$\begin{array}{r} 120 \\ - 96 \\ \hline 24 \end{array}$$

Cevap: C

77.

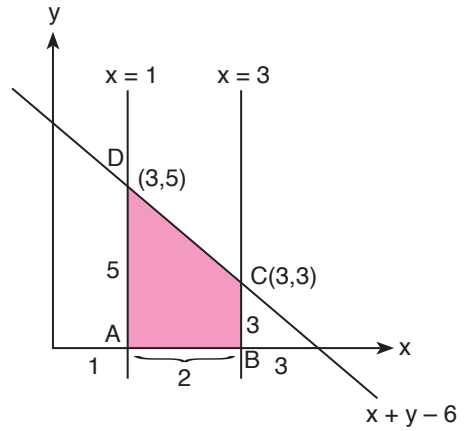

$$x = 1 \text{ için } 1 + y - 6 = 0 \Rightarrow y = 5$$

$$x = 3 \text{ için } 3 + y - 6 = 0 \Rightarrow y = 3$$

$$\Rightarrow A(ABCD) = \frac{5+3}{2} \cdot 2 = 8 \text{ br}^2 \text{ olur.}$$

Cevap: A

78.

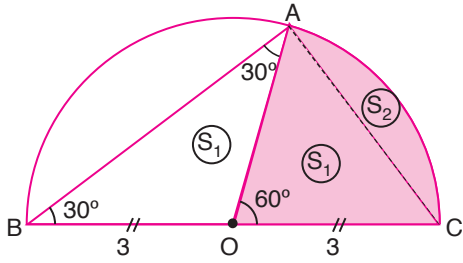

$$S_1 + S_2 = \pi \cdot 3^2 \cdot \frac{60}{360}$$

$$= \frac{9\pi}{6} = \frac{3\pi}{2}$$

Cevap: B

79.

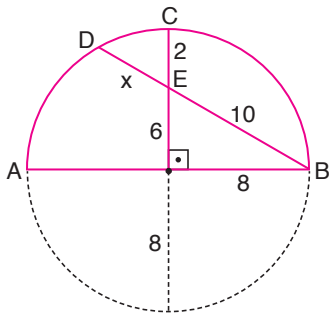

$$x \cdot 10 = 2 \cdot 14$$

$$10 \cdot x = 28$$

$$\boxed{x = 2,8}$$

Cevap: E

80.

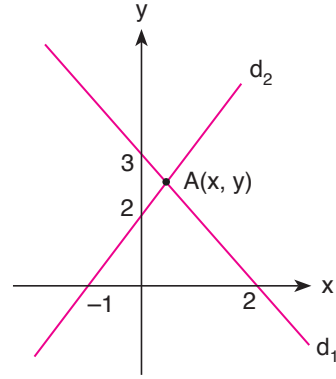

$$d_1: \frac{x}{3} + \frac{y}{2} = 1 \rightarrow 3x + 2y = 6$$

$$d_2: \frac{x}{-1} + \frac{y}{2} = 1 \rightarrow y - 2x = 2 \text{ olur.}$$

O halde

$$\begin{cases} 3x + 2y = 6 \\ -2y + 4x = 2 \end{cases} \rightarrow \begin{array}{r} 3x + 2y = 6 \\ + -2y + 4x = 2 \\ \hline 7x = 2 \end{array}$$

$$\boxed{x = \frac{2}{7}} \text{ olur.}$$

$$\begin{cases} y - \frac{4}{7} = 2 \\ y = 2 + \frac{4}{7} \end{cases} \left. \begin{array}{l} \text{O halde} \\ x + y = \frac{2}{7} + \frac{18}{7} \\ x + y = \frac{20}{7} \end{array} \right\} \begin{array}{l} \boxed{y = \frac{18}{7}} \\ x + y = \frac{20}{7} \end{array}$$

Cevap: E